

MAXIMUS
BY
ViSAGE™

MEN'S GROOMING KIT

BARBER FRESH,
IN YOUR OWN
BATHROOM



Model Number: AP210214

Product Number: 705929

INSTRUCTION MANUAL

Version 1.4 - Issued 02/02/21



Congratulations on purchasing a Visage® product. All products brought to you by Visage® are manufactured to the highest standards of performance and safety, as part of our philosophy of customer service and satisfaction. We offer a comprehensive 1 Year Warranty.

We hope you will enjoy using your Men's Grooming Kit for many years to come.

Warranty Note

Getting the most out of your Men's Grooming Kit:



Read the entire manual

It will help you set up with ease



Visit www.balcobrands.com

We have additional support guides available



Call After Sales Support - 1300 663 907

Or email customer@balcobrands.com - we're always happy to help

If you experience any issues with this product or its performance is not what you had expected, please contact our friendly customer service team

It is likely that we can resolve problems for you via phone or email

We can be reached on:

Phone: 1300 663 907

Email: customer@balcobrands.com

Web: www.balcobrands.com



| | |
|--|----|
| Welcome | 2 |
| Warranty Note | 2 |
| General Safety Instructions | 5 |
| Product Overview | 6 |
| Assembly & Parts List | 6 |
| Technical Specifications | 6 |
| Getting Started | 7 |
| Before First Use | 7 |
| Charging | 7 |
| Changing heads | 7 |
| Operation | 8 |
| Hair clipper/trimmer | 8 |
| Using the adjustable slider comb | 8 |
| Contouring without comb attachments | 8 |
| Nose & ear hair trimmer | 8 |
| Trimming ear hair | 8 |
| Trimming eyebrows | 8 |
| Precision sideburn trimmer | 8 |
| Beard & body shaver | 9 |
| Double foil shaver | 9 |
| Turbo mode | 9 |
| FAQs & Troubleshooting | 10 |
| Cleaning & Maintenance | 10 |
| Disposal | 10 |
| Repair and Refurbished Goods or Parts Notice | 11 |

After Sales Support

 1300 663 907

 customercare@balcobrands.com





ViSAGE®

MEN'S GROOMING KIT



Warranty Details

REGISTER YOUR PURCHASE AT www.aldi.com.au/en/about-aldi/product-registration/ TO KEEP UP-TO-DATE WITH IMPORTANT PRODUCT INFORMATION

The product is guaranteed to be free from defects in workmanship and parts for a period of 12 months from the date of purchase. Defects that occur within this warranty period, under normal use and care, will be repaired, replaced or refunded at our discretion. The benefits conferred by this warranty are in addition to all rights and remedies in respect of the product that the consumer has under the Competition and Consumer Act 2010 and similar state and territory laws.

Our goods come with guarantees that cannot be excluded under the Australian Consumer Law. You are entitled to a replacement or refund for a major failure and for compensation for any other reasonably foreseeable loss or damage. You are also entitled to have the goods repaired or replaced if the goods fail to be of acceptable quality and the failure does not amount to a major failure.

AFTER SALES SUPPORT

  1300 663 907

 customercare@balcobrands.com

MODEL: AP210214 PRODUCT CODE: 705929 08/2021



Before using the appliance for the first time, you must read and understand the operation manual completely.

General Safety Warnings

- Polythene bags over the product or packaging may be dangerous. To avoid danger of suffocation, keep away from babies and children. These bags are not toys.
- Keep away from water.
- **WARNING:** Keep the appliance and USB charging cable dry.
- This product is intended for domestic use only. It is not intended for commercial, trade or industrial use.
- Do not place or store the appliance where it can fall or be pulled into a sink or bath.
- Do not reach for an appliance that has fallen into water. Unplug it immediately.
- Do not use while bathing or in the shower.
- Do not place or drop into water or other liquid.
- Do not use in dusty conditions.
- Do not drop the appliance. Dropping or rough use of the unit may cause damage.
- Do not place near strong magnets or strong electric currents.
- If the appliance is not in use, turn off and unplug from any power source.
- Do not attempt to repair, open or alter any components of the appliance. In the case of improper usage or if you have opened, altered and repaired the product yourself, all guarantees are void.
- If the USB cable is damaged, do not use the product. Contact customer service for repair or replacement.
- The supplier does not accept responsibility for additional or consequential damage other than covered by legal product responsibility.
- The supplier is not responsible for the end use of this product including any improper use or when used for purposes that are not specified.
- If the appliance is subjected to a major change in temperature, pressure, or humidity, let the appliance acclimatise for 30 minutes before you use it.
- Always check the appliance before you use it. Do not use the appliance if the blades, trimmers or attachments are damaged or broken, as this may cause injury.
- This appliance is not intended for use by persons (including children) with reduced physical, sensory or mental capabilities, or lack of experience and knowledge, unless they have been given supervision or instruction concerning the use of the appliance by a person responsible for their safety.
- Children should be supervised to ensure that they do not play with the appliance and accessories.
- Use, charge and store the appliance at a temperature between 15°C and 35°C.
- Unplug the appliance before cleaning.
- Keep the appliance and power cable away from heat sources and hot surfaces.
- Always protect the power cable from undue flexing and wearing – do not allow the cable to hang off edge of the counter or table.
- Do not wrap the cord around the appliance.
- Do not leave the appliance unattended when it is plugged in.
- Store the appliance in a moisture-free area.
- Always make sure blades are aligned properly.
- To disconnect, turn all controls to OFF, then remove the cord from the electrical outlet.
- Do not use an extension cord or a voltage converter with the appliance.
- Do not use this appliance with an external timer or separate remote-control system of any kind.
- Do not operate with aerosol spray products or where oxygen is being administered.
- Never use compressed air, scouring pads, abrasive cleaning agents or aggressive liquids such as petrol or acetone to clean the appliance.
- The product must only be supplied at safety extra low voltage corresponding to the marking on the appliance.
- The supply terminals are not to be short-circuited.
- **WARNING:** Use only an external supply with 5V DC 1A output.
- This appliance contains battery that is non-replaceable. When the battery is at end of life, the appliance shall be properly disposed of.
- Do not expose the appliance or battery to excessive temperatures.
- Be aware of the risk of terminal of the battery operated appliance or battery being short circuited by metal objects.
- Do not expose battery to heat or fire. Avoid storage in direct sunlight.
- In the event of a battery leaking, do not allow the liquid to come in contact with skin or eyes. If contact has been made, wash the affect area with copious amounts of water and seek medical advice.
- Dispose of used batteries to local regulations properly.



This product has been tested to AS/NZS 60335.1 and AS/NZS 60335.2.8.

After Sales Support

☎ 1300 663 907

💻 customercare@balcobrands.com



Product Overview

Men's Grooming Kit

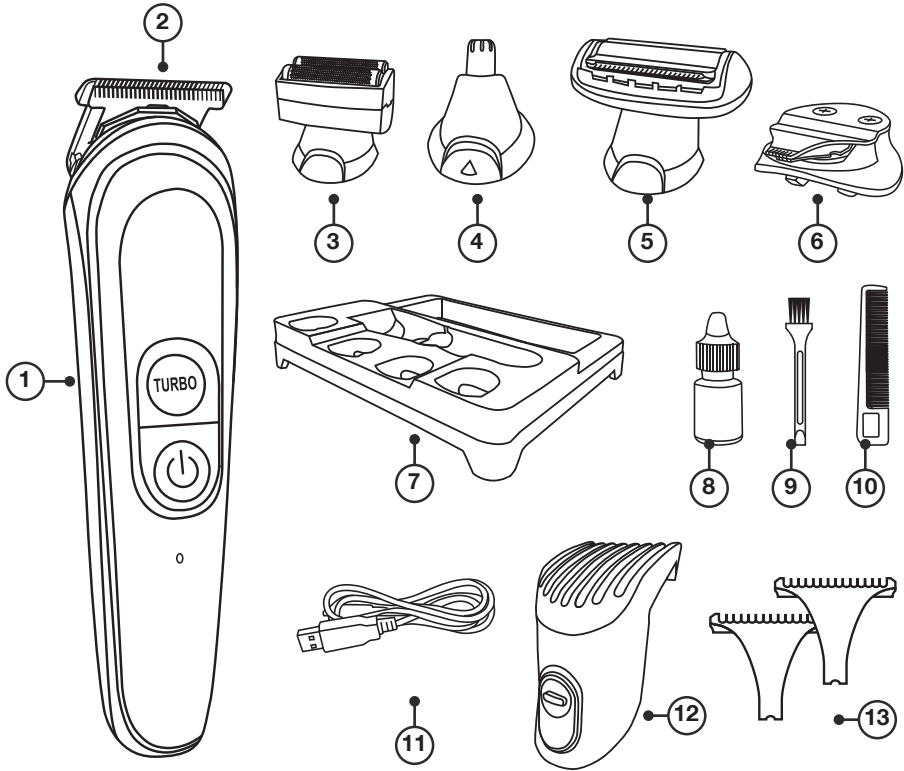

Assembly & Parts List

- 1. Body
- 2. Hair clipper/trimmer
- 3. Double foil shaver
- 4. Nose/ear hair trimmer with round blades
- 5. Beard & body shaver
- 6. Precision sideburn trimmer
- 7. Storage base
- 8. Oil
- 9. Cleaning brush
- 10. Styling comb
- 11. USB cable
- 12. Adjustable slider comb (3, 5, 7, 9, 11mm)
- 13. Clip on side combs (1 & 2mm)

Technical Specifications

Model number: AP210214
Warranty: 1 Year
Battery Capacity: 3.7V 600mAh 2.22Wh
Input Rating: 5V DC 1A
Battery Type: Li-ion Cell

After Sales Support

☎ 1300 663 907

💻 customercare@balcobrands.com



Before First Use

Remove any packaging material and promotional labels before using your grooming kit for the first time.

Fully unwind the USB power cord and inspect it for damage. Do not use the appliance if any part has been damaged. In case of damage, contact our after sales support line for advice on replacement or return.

Charging

Before first use of your grooming kit, it is recommended to fully charge the unit. The appliance has an approximate charge time of 90 minutes and a running time of 90 minutes

1. Insert the USB charging cord into the base of the appliance.
2. Insert the USB end into a USB power source (not included) and ensure the power source is switched on.
3. The LED on the shaver will turn red indicating the appliance is charging.
4. After 90 minutes, turn OFF the power source.

NOTE: The charging light will turn red when it is charging and will turn blue when fully charged

Changing heads

The grooming kit has 5 interchangeable heads. These should only be changed when the appliance is switched off. All attachments can be attached and detached in the same way.

1. Grip the main body and place the desired attachment head at the top
2. Push the bottom end of the attachment firmly until it locks into place
3. To remove a head attachment, grip the main body and push the attachment head upwards until it unlocks and remove

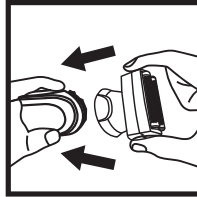

Attach

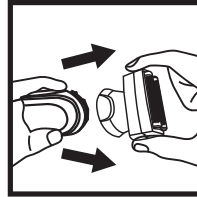

Remove

Hair clipper/trimmer

Only use the appliance on clean, dry hair.

Using the adjustable slider comb

1. Slide the adjustable slider comb into the guiding grooves on both sides of the shaver body.
2. When you are trimming for the first time, start at the maximum trimming length 11mm comb to familiarise yourself with the appliance. Using setting 3mm comb installed will result in a stubble look.
3. Switch on the appliance.
4. Move the appliance through the hair slowly.
5. Make sure that the flat part of the comb is always fully in contact with the scalp to obtain an even result.
6. Make overlapping passes over the head to ensure that you cut all the hair that needs to be cut.
7. Regularly remove cut hair from the comb.

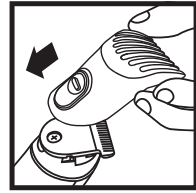

NOTE: To clip in the most effective way, move the appliance against the direction of hair growth. Since all hair does not grow in the same direction, you need to move the appliance in different directions

Contouring without comb attachments

You can use the appliance without a comb attachment to clip hair very close to the skin (0.6mm) or to contour the neckline and the area round the ears.

- Be careful when you clip without the comb because the cutting blade removes every hair it touches.
- Before you start to contour the hairline around the ears, comb the hair ends over the ears.
- Tilt the appliance in such a way that only one edge of the cutting element touches the hair ends when you shape the contours around the ears.
- Only cut the hair ends. The hairline should be close to the ear.
- To contour the neckline and sideburns, turn the appliance and make downward strokes. Move the appliance slowly and smoothly. Follow the natural hairline.

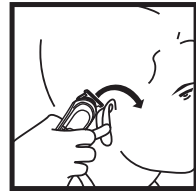

Nose & ear hair trimmer

Trimming ear hair

1. Attach the nose/ear hair trimmer head.
2. Clean the outer ear canal. Make sure it is free from wax.
3. Switch on the appliance and move the tip softly around the ear to remove hairs that stick out beyond the rim of the ear.
4. Carefully insert the tip into the outer ear canal.
5. Do not insert the tip more than 5mm into the ear canal as this could damage the eardrum.

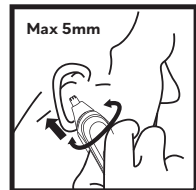

Trimming eyebrows

1. Use the tip to cut individual eyebrow hairs.
2. Do not use the appliance to define or trim the entire eyebrow.

NOTE: Never try to trim your eyelashes. Never come too close to your eyes.



Precision sideburn trimmer

Use the precision trimmer to shape your moustache and sideburns, to define contour and to remove single hairs.

1. Hold the appliance upright and trim the desired areas.
2. Make careful and controlled movements.



Beard & body shaver

It is designed for shaving and trimming of hair on legs, chest and underarms.

Use it on dry skin only.

1. Click the body groomer head onto the main body.
2. Hold the appliance upright and trim the desired areas.
3. Make careful and controlled movements.



Double foil shaver

1. Before using the shaver, always check it for wear and damage. If the shaver shows signs of wear or damage, do not use or it may cause injury.
2. If required, pre-trim the desired area to a shorter hair length using the hair trimmer or precision sideburn trimmer.
3. Attach the double foil shaver attachment and gently press the shaver onto the skin and shave along contoured edges to remove any stubbles. Do not press too hard.
4. Any areas that are harder to shave, such as chin, stretch the skin for a better result.

Turbo mode

Shave even faster through dense parts of your beard or hair with the extra power boost you get by activating Turbo mode

After Sales Support

☎ 1300 663 907

💻 customercare@balcobrands.com



| Problem | Solution |
|---|---|
| Why isn't my grooming kit turning on? | Ensure the battery is fully charged. Refer to page 7 to charging instructions. |
| The grooming kit isn't removing any hair. | The blades may be affected by hair or other particles. Ensure you regularly clean the attachment heads after use. |

Cleaning & Maintenance

- Switch off the appliance.
- Take off any head and comb.
- Use the brush to clean the heads, combs and the appliance. Do not clean the foil of the body groomer head with the brush as it may be damaged.
- The foil head must be detached from the main body before cleaning. It can be cleaned with lukewarm water.
- To keep the appliance working properly, oil it with light machine oil regularly.
- Before cleaning the appliance and attachments, ensure they are turned off and unplugged from power.
- To maintain optimum performance, the appliance should be cleaned after each use.

CAUTION: KEEP THE APPLIANCE AND THE USB CABLE DRY. ONLY CLEAN THE APPLIANCE AND THE USB CABLE WITH THE CLEANING BRUSH SUPPLIED. NEVER USE COMPRESSED AIR, SCOURING PADS, ABRASIVE CLEANING AGENTS OR AGGRESSIVE LIQUIDS SUCH AS ALCOHOL, PETROL OR ACETONE TO CLEAN THE APPLIANCE. DO NOT USE ANY SHARP OBJECTS TO CLEAN THE APPLIANCE.

Disposal

At the end of its working life, do not throw this product out with your household rubbish. Electrical and electronic products contain substances that can have a detrimental effect on the environment and human health if disposed of inappropriately. Observe any local regulations regarding the disposal of electrical consumer goods and dispose of it appropriately for recycling. Contact your local authorities for advice on recycling facilities in your area. Please keep the original packaging carton and materials in a safe place. It will help to prevent any damage if the product needs to be transported in the future. In the event it is to be disposed of, please recycle all packaging material where possible.

After Sales Support

☎ 1300 663 907

💻 customercare@balcobrands.com





ViSAGE®

MEN'S GROOMING KIT

Repair and Refurbished Goods or Parts Notice

Unfortunately, from time to time, faulty products are manufactured which need to be returned to the Supplier for repair.

Please be aware that if your product is capable of retaining user-generated data (such as files stored on a computer hard drive, telephone numbers stored on a mobile telephone, songs stored on a portable media player, games saved on a games console or files stored on a USB memory stick) during the process of repair, some or all of your stored data may be lost.

We recommend you save this data elsewhere prior to sending the product for repair.

You should also be aware that rather than repairing goods, we may replace them with refurbished goods of the same type or use refurbished parts in the repair process.

Please be assured though, refurbished parts or replacements are only used where they meet ALDI's stringent quality specifications.

If at any time you feel your repair is being handled unsatisfactorily, you may escalate your complaint. Please telephone us on 1300 663 907 or write to us at:



Balco Brands Pty Ltd

PO Box 537 Bayswater Business Centre, Victoria, Australia

1300 663 907 - Hours: Mon-Fri 8:30am - 6:00pm AEST

customercare@balcobrands.com

AFTER SALES SUPPORT

  1300 663 907

 customercare@balcobrands.com

MODEL: AP210214 PRODUCT CODE: 705929 08/2021



MAXIMUS

BY

ViSAGE®